

PASSENGER CB SWITCH AND ATTACHMENT

Accessory Name	Parts Number	Application Model	Issue Date	Publication No.
PASSENGER CB SWITCH AND ATTACHMENT	08E82-MKC-A00	GL1800/D	February 2025	MII 55305

Introduction

ALL INFORMATION, ILLUSTRATIONS, DIRECTIONS AND SPECIFICATIONS INCLUDED IN THIS PUBLICATION ARE BASED ON THE LATEST PRODUCT INFORMATION AVAILABLE AT THE TIME OF APPROVAL FOR PRINTING. Honda Motor Co., Ltd. RESERVES THE RIGHT TO MAKE CHANGES AT ANY TIME WITHOUT NOTICE AND WITHOUT INCURRING ANY OBLIGATION WHATSOEVER. NO PART OF THIS PUBLICATION MAY BE REPRODUCED WITHOUT WRITTEN PERMISSION. THIS MANUAL IS WRITTEN FOR PERSONS WHO HAVE ACQUIRED BASIC KNOWLEDGE OF MAINTENANCE ON Honda MOTORCYCLES, MOTOR SCOOTERS, ATVS OR SXSS.

Honda Dealer:







Please give a copy of these instructions to your customer.

Customer:

Because the installation of this accessory requires specialized knowledge, special tools and equipment, it is recommended to only install it at a dealer with qualified technicians.

How To Read These Symbols

Your safety, and the safety of others, is very important. To help you make informed decisions we have provided safety messages and other information throughout this manual.

-  **WARNING** You CAN be KILLED or SERIOUSLY HURT if you don't follow instructions.
-  **CAUTION** You CAN be HURT if you don't follow instructions.
-  **NOTICE** The purpose of this message is to help prevent damage to your vehicle, other property, or the environment.
-  **NOTE** Things you want to know, things that are useful to know.
-  Follow the instructions of the Service Manual.
-  Follow the other instruction symbols of the "Basic Shop Manual".

Other Instruction Symbols

The symbols used throughout these instructions show specific "Warnings and Notices". Refer to the "Basic Shop Manual" for the description of each symbol.

INFORMATION

CAUTION

- To prevent burns, allow the engine, exhaust system, radiator, etc., to cool before installing the accessory.

NOTICE

- Take care not to damage the painted surfaces of the motorcycle.

NOTE:

- Reinstall the removed parts on the motorcycle and make sure that the wires and harnesses are not pinched.
- Disconnect the negative (–) cable from the battery before installing this accessory.
- Trim the excess ends off the wire ties after attaching them to the wire harnesses. Do not allow the cut part of the wire tie to interfere with another harness or brake hose.
- After reconnecting the battery, refer to the motorcycle Owner's Manual and set the meter.
- After this accessory installation, check the lights (e.g. right/left turn signal lights and brake lights) for proper operation.
- Setting is necessary after installing this accessory
- Save all removed parts unless otherwise indicated.

TORQUE INFORMATION

Refer to the Service Manual for the torque values including standard torque of the removed parts. ()

PARTS LIST

<PASSENGER CB SWITCH AND ATTACHMENT>

Component	No.	Parts Name	Qty	Parts No.
	(1)	Passenger CB switch assembly	1	
	(2)	4 x 20 mm screw	2	93901-24320
	(3)	Wire tie (165 mm)	1	90651-KV6-003
	(4)	Left saddlebag switch cover	1	

INSTALLATION

1. Refer to the Service Manual for motorcycle, remove the motorcycle parts as shown. (📖)

Open the lid.
(Both sides)

(📖) (Left side only)
Step 3

(📖)
Step 2

(📖) (Both sides)
Step 1

Disconnect the battery (-) cable.

INSTALLATION IMAGE

<LEFT SIDE>

2. Remove the motorcycle parts as shown.

<LEFT SIDE>

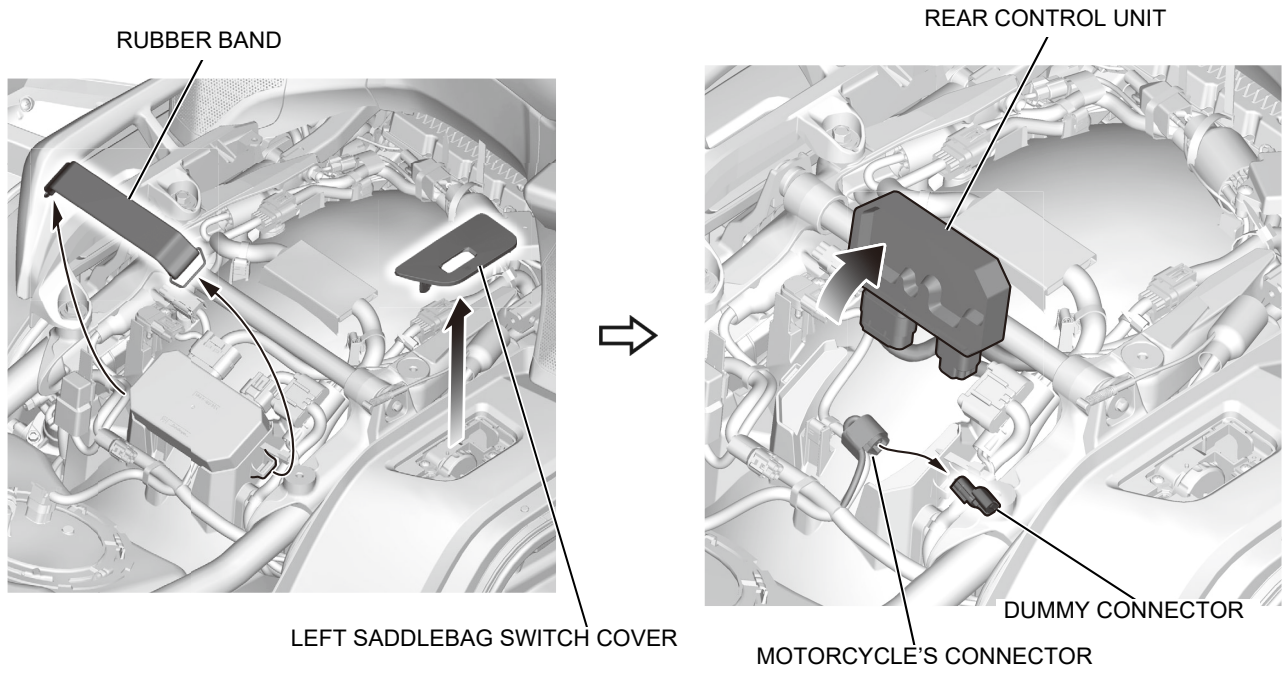

3. Install as shown.

<LEFT SIDE>

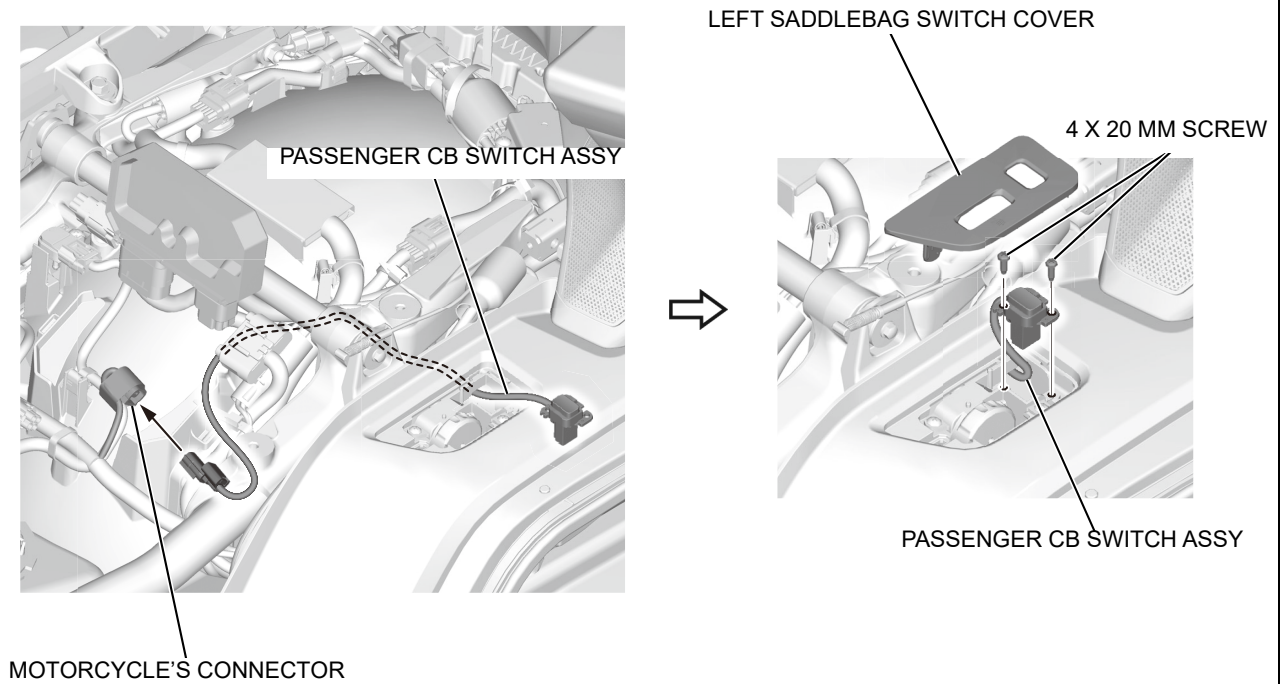

4. Secure with the wire tie as shown.
- Cut off the excess end of the wire tie, leaving a maximum of 5 mm.

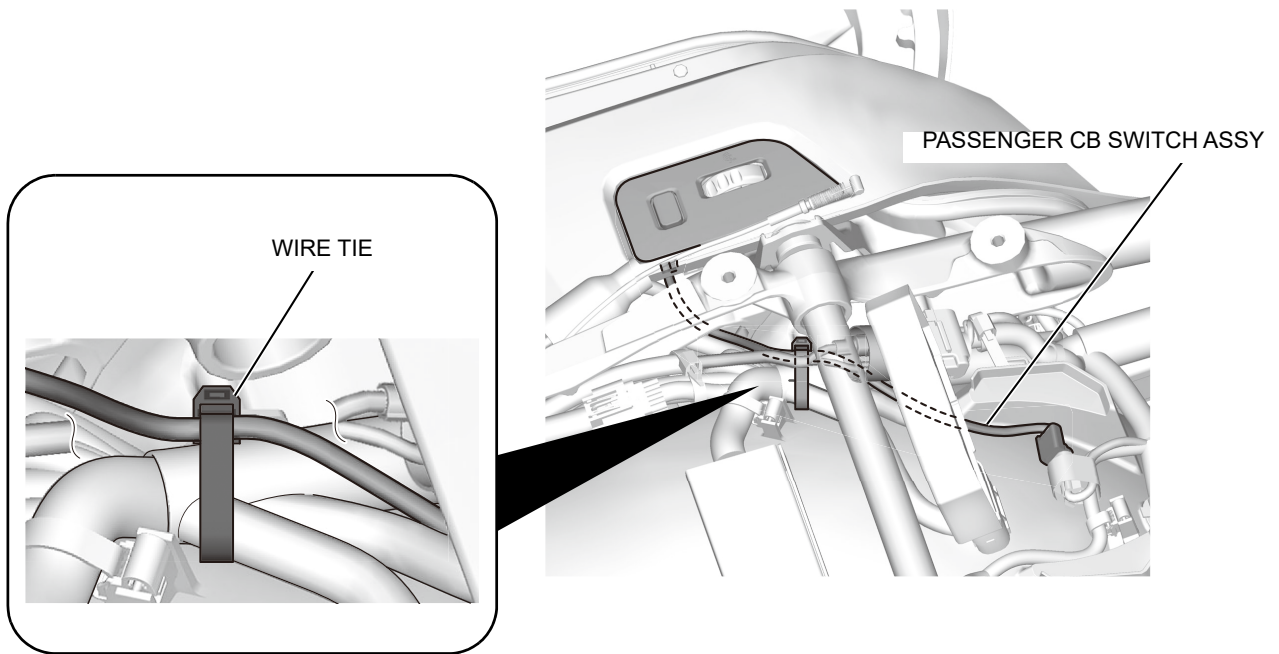

5. Install the motorcycle parts in the reverse order of removal.
- Confirm that any harness is not caught or too tight.